

LED Flood/Parking Lot Light

80W-180W

110lm/w high efficiency for fixture

Mounting arms types A/C/E optional

3 types of Lighting distribution for choices

Photocell and Surge Protection devices are available

DLC ETL + Philips + Inventronics + 5 years warranty



Specifications

Item Number	Wattage	Voltage	Power Factor	Lumen	CRI	CCT	Chips	IP Rated	Life Span
FL80W-X	80W	100-277Vac	>0.95	9000lm	Ra>80	3000K-6000K	Philips	IP65	>50000Hrs
FL100W-X	100W	100-277Vac	>0.95	11000lm	Ra>80	3000K-6000K	Philips	IP65	>50000Hrs
FL120W-X	120W	100-277Vac	>0.95	13200lm	Ra>80	3000K-6000K	Philips	IP65	>50000Hrs
FL150W-X	150W	100-277Vac	>0.95	16500lm	Ra>80	3000K-6000K	Philips	IP65	>50000Hrs
FL180W-X	180W	100-277Vac	>0.95	20000lm	Ra>80	3000K-6000K	Philips	IP65	>50000Hrs
FL80WHV-X	80W	220-480Vac	>0.95	9000lm	Ra>80	3000K-6000K	Philips	IP65	>50000Hrs
FL100WHV-X	100W	220-480Vac	>0.95	11000lm	Ra>80	3000K-6000K	Philips	IP65	>50000Hrs
FL120WHV-X	120W	220-480Vac	>0.95	13200lm	Ra>80	3000K-6000K	Philips	IP65	>50000Hrs
FL150WHV-X	150W	220-480Vac	>0.95	16500lm	Ra>80	3000K-6000K	Philips	IP65	>50000Hrs
FL180WHV-X	180W	220-480Vac	>0.95	20000lm	Ra>80	3000K-6000K	Philips	IP65	>50000Hrs

Packaging

Item Number	Wattage	Piece	Carton size	GW (kg)
FL80W-X	80W	1pcs/CTN	55*35*15cm(A) 46.5*36*15cm(C.E)	6.05kg(A) 5.4kg(C.E)
FL100W-X	100W	1pcs/CTN	55*35*15cm(A) 46.5*36*15cm(C.E)	6.05kg(A) 5.4kg(C.E)
FL120W-X	120W	1pcs/CTN	61.5*40*15cm(A) 52*40*15(C.E)	7.5kg(A) 6.8kg(C.E)
FL150W-X	150W	1pcs/CTN	61.5*40*15cm(A) 52*40*15(C.E)	7.5kg(A) 6.8kg(C.E)
FL180W-X	180W	1pcs/CTN	61.5*40*15cm(A) 52*40*15(C.E)	7.5kg(A) 6.8kg(C.E)
FL80WHV-X	80WHV	1pcs/CTN	55*35*15cm(A) 46.5*36*15cm(C.E)	6.5kg(A) 5.8kg(C.E)
FL100WHV-X	100WHV	1pcs/CTN	55*35*15cm(A) 46.5*36*15cm(C.E)	6.5kg(A) 5.8kg(C.E)
FL120WHV-X	120WHV	1pcs/CTN	61.5*40*15cm(A) 52*40*15(C.E)	8kg(A) 7.25kg(C.E)
FL150WHV-X	150WHV	1pcs/CTN	61.5*40*15cm(A) 52*40*15(C.E)	8kg(A) 7.25kg(C.E)
FL180WHV-X	180WHV	1pcs/CTN	61.5*40*15cm(A) 52*40*15(C.E)	8kg(A) 7.25kg(C.E)

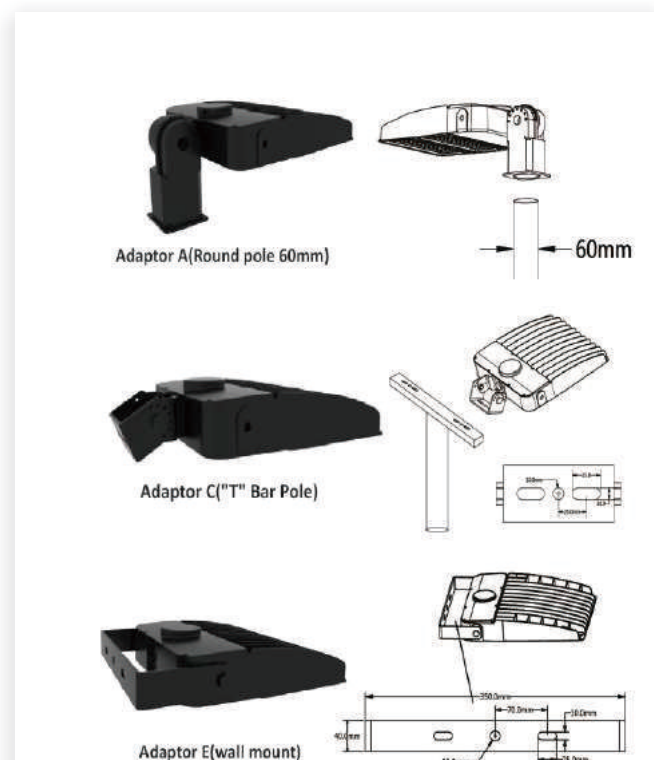

✓ DIFFERENT ADAPTOR OPTIONAL



Photocell

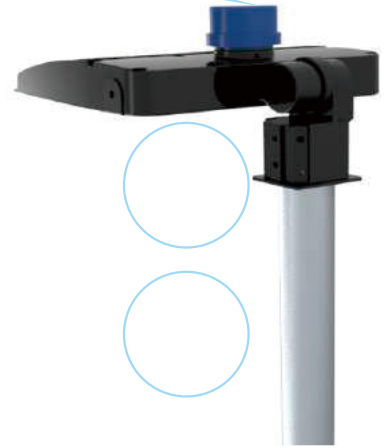

✓ DIFFERENT LIGHT DISTRIBUTION

60° Symmetrical

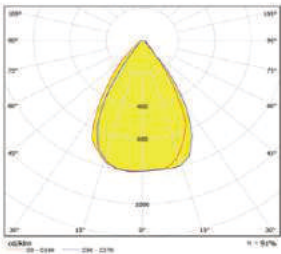
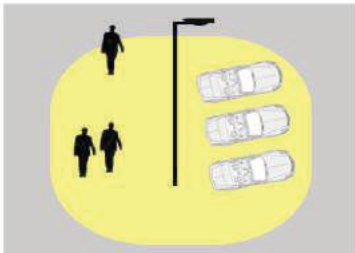

90° Symmetrical

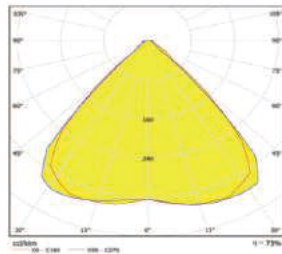
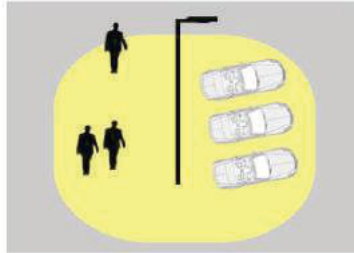

62-144° Asymmetrical

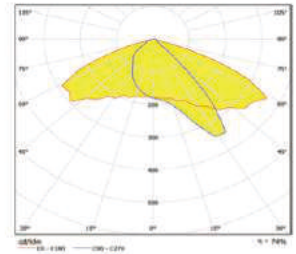
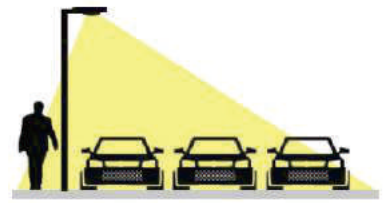

✓ PRODUCT SIZE

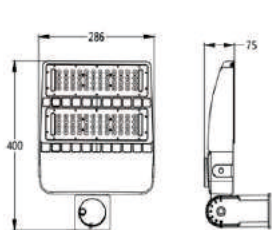

FL80W-100W/A
FL80WHV-100WHV/A

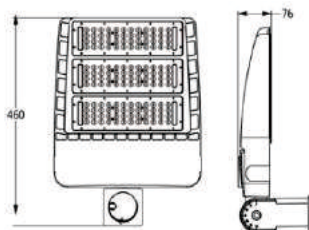

FL120W-180W/A
FL120WHV-180WHV/A

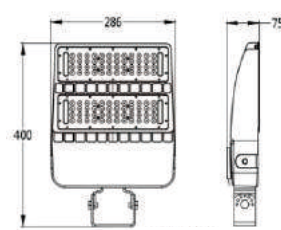

FL80W-100W/C
FL80WHV-100WHV/C

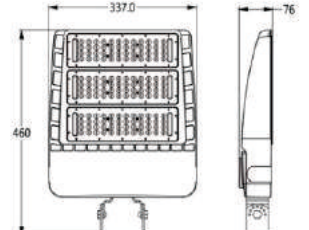

FL120W-180W/C
FL120WHV-180WHV/C

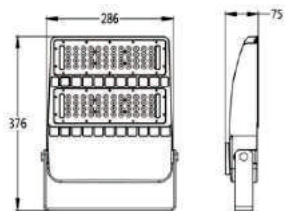

FL80W-100W/E
FL80WHV-100WHV/E

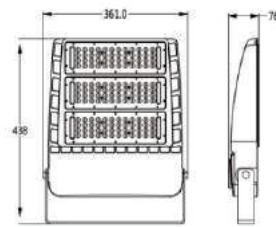

FL120W-180W/E
FL120WHV-180WHV/E